

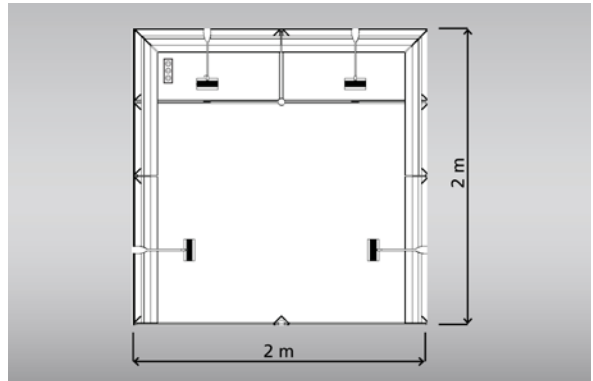

COMPLETE STANDS

Small stand classic S (4 m²)

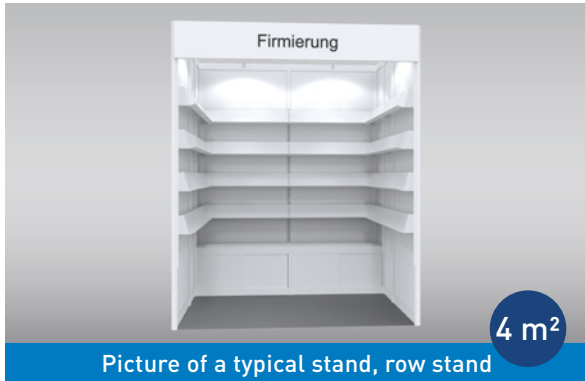

Our services

- | **Partition wall system**, 100x250 cm (WxH), white (other colours at additional price)
- | **Lettering** (Futura, dark grey), 10 cm high, max. 25 signs
- | **Fascia**, 30 cm high, white
- | **Bookshelves**, white
- | **Platforms with sliding doors**, white (please order door lock separately)
- | **Lighting**, 3 Long-arm spotlight
- | **Needle-felt floor covering**
- | **Triple socket** (The power connection will be charged separately and is compulsory)

Additional services

Depending on the registered size of your stand, you will receive a number of free exhibitor passes and can register events for the Leipzig liest reading festival. You can find out how many in the Special Conditions of Participation or on page 20.

Sample quote	Registration by 30.09.2022 (Early-bird)	Registration from 01.10.2022
Trade fair rental incl. stand construction (4 m ²)	€ 752.00	€ 828.00
AUMA fee	€ 2.40	€ 2.40
Electrical connection (compulsory)	€ 154.00	€ 154.00
Communication flat rate (i.e. compulsory entry in the exhibitor directory)	€ 89.00	€ 89.00
Free exhibitor passes (for the main exhibitor according to Stand size + one pass for each co-exhibitor)	2 passes	2 passes
Co-exhibitor fee, where applicable		
Leipzig liest fee 1, where applicable		
Leipzig liest fee 2, where applicable		
Total costs	€ 997.40	€ 1,073.40

Updated: July 2022, subject to change

All prices plus VAT.



COMPLETE STANDS

Small stand classic M (6 m²)

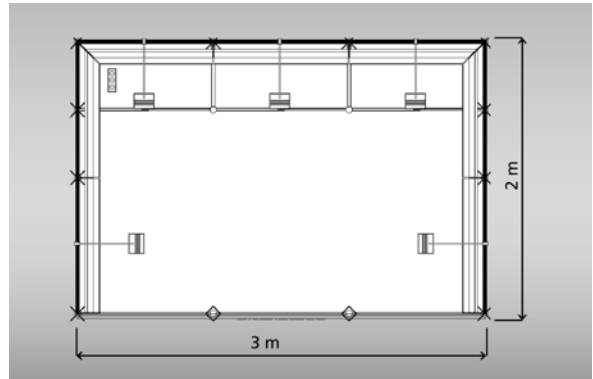
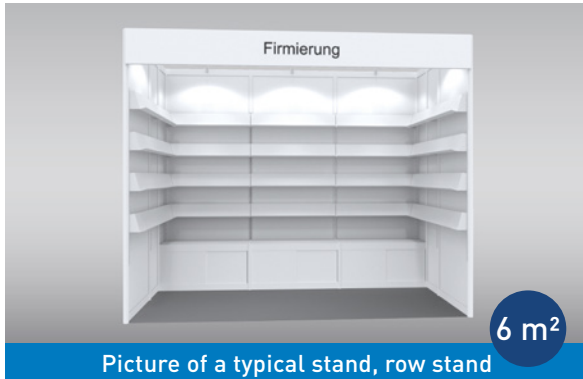

Our services

- | **Partition wall system**, 100x250 cm (WxH), white (other colours at additional price)
- | **Lettering** (Futura, dark grey), 10 cm high, max. 25 signs
- | **Fascia**, 30 cm high, white
- | **Bookshelves**, white
- | **Platforms with sliding doors**, white (Please order door lock separately)
- | **Lighting**, 5 Long-arm spotlight
- | **Needle-felt floor covering**
- | **Triple socket** (The power connection will be charged separately and is compulsory)

Additional services

Depending on the registered size of your stand, you will receive a number of free exhibitor passes and can register events for the Leipzig liest reading festival. You can find out how many in the Special Conditions of Participation or on page 20.

Sample quote	Registration by 30.09.2022 (Early-bird)	Registration from 01.10.2022
Trade fair rental incl. stand construction (6 m ²)	€ 1,200.00	€ 1,320.00
AUMA fee	€ 2.40	€ 2.40
Electrical connection (compulsory)	€ 154.00	€ 154.00
Communication flat rate (i.e. compulsory entry in the exhibitor directory)	€ 89.00	€ 89.00
Free exhibitor passes (for the main exhibitor according to Stand size + one pass for each co-exhibitor)	3 passes	3 passes
Co-exhibitor fee, where applicable		
Leipzig liest fee 1, where applicable		
Leipzig liest fee 2, where applicable		
Total costs	€ 1,446.60	€ 1,566.60

Updated: July 2022, subject to change

All prices plus VAT.



COMPLETE STANDS

Small stand classic S without partition (4 m²)



Picture of a typical stand, row stand

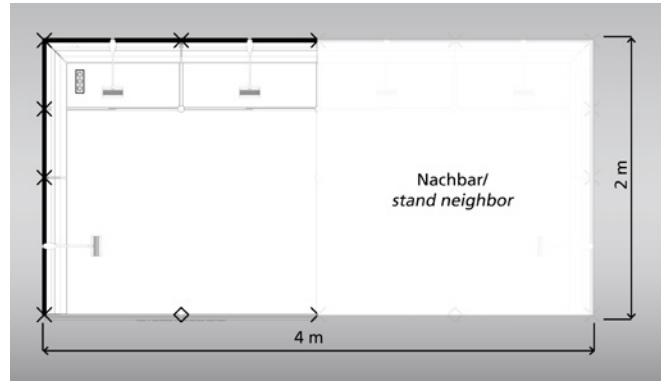

Our services

- | **Partition wall system**, 100x250 cm (WxH), white (other colours at additional price)
- | **Lettering** (Futura, dark grey), 10 cm high, max. 25 signs
- | **Fascia**, 30 cm high, white
- | **Bookshelves**, white
- | **Platforms with sliding doors**, white (Please order door lock separately)
- | **Lighting**, 3 Long-arm spotlight
- | **Needle-felt floor covering**
- | **Triple socket** (The power connection will be charged separately and is compulsory)

Additional services

Depending on the registered size of your stand, you will receive a number of free exhibitor passes and can register events for the Leipzig liest reading festival. You can find out how many in the Special Conditions of Participation or on page 20.

Sample quote	Registration by 30.09.2022 (Early-bird)	Registration from 01.10.2022
Trade fair rental incl. stand construction (4 m ²)	€ 1,016.00	€ 1,120.00
AUMA fee	€ 2.40	€ 2.40
Electrical connection (compulsory)	€ 154.00	€ 154.00
Communication flat rate (i.e. compulsory entry in the exhibitor directory)	€ 89.00	€ 89.00
Free exhibitor passes (for the main exhibitor according to Stand size + one pass for each co-exhibitor)	2 passes	2 passes
Co-exhibitor fee, where applicable		
Leipzig liest fee 1, where applicable		
Leipzig liest fee 2, where applicable		
Total costs	1.261,40 €	1.365,40 €

Updated: July 2022, subject to change



COMPLETE STANDS

Small stand creative Pro S (4 m²)

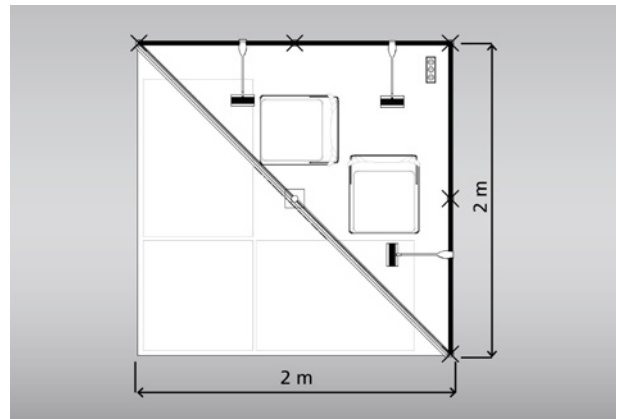

Our services

- | **Partition wall system**, 100x250 cm (WxH), white (other colours at additional price)
- | **Lettering** (Futura, dark grey), 10 cm high, max. 25 Signs
- | **Fascia**, 30 cm high, white
- | **Lighting**, 3 Long-arm spotlight
- | **Needle-felt floor covering**
- | **Triple socket** (The power connection will be charged separately and is compulsory)
- | **2 "Miami" folding chairs**, Seat/backrest/frame: black, 33x35x47/72 cm
- | **3 "Newport" tables**, black, 70x70 cm, 100x70 cm, 120x70 cm

Additional services

Depending on the registered size of your stand, you will receive a number of free exhibitor passes and can register events for the Leipzig liest reading festival. You can find out how many in the Special Conditions of Participation or on page 20.

Sample quote	Registration bis 30.09.2022 (Early-bird)	Registration ab 01.10.2022
Trade fair rental incl. stand construction (4 m ²)	€ 752.00	€ 828.00
AUMA fee	€ 2.40	€ 2.40
Electrical connection (compulsory)	€ 154.00	€ 154.00
Communication flat rate (i.e. compulsory entry in the exhibitor directory)	€ 89.00	€ 89.00
Free exhibitor passes (for the main exhibitor according to Stand size + one pass for each co-exhibitor)	2 passes	2 passes
Co-exhibitor fee, where applicable		
Leipzig liest fee 1, where applicable		
Leipzig liest fee 2, where applicable		
Total costs	€ 997.40	€ 1,073.40

Updated: July 2022, subject to change



COMPLETE STANDS

Small stand creative Pro M (6 m²)



Picture of a typical stand

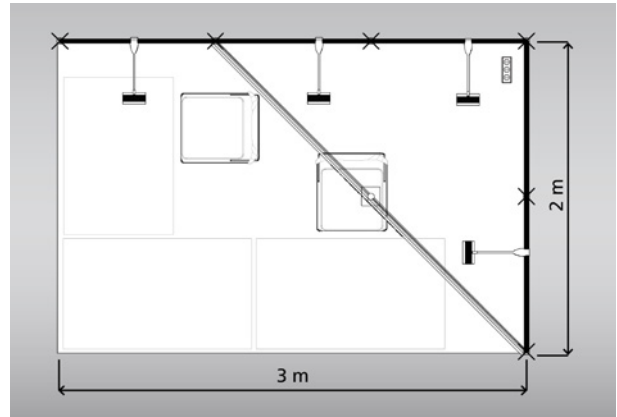

Our services

- | **Partition wall system**, 100x250 cm (WxH), white (other colours at additional price)
- | **Lettering** (Futura, dark grey), 10 cm high, max. 25 Signs
- | **Fascia**, 30 cm high, white
- | **Lighting**, 4 Long-arm spotlight
- | **Needle-felt floor covering**
- | **Triple socket** (The power connection will be charged separately and is compulsory)
- | **2 "Miami" folding chairs**, Seat/backrest/frame: black, 33x35x47/72 cm
- | **3 tables "Newport"**, black, 120x70 cm

Additional services

Depending on the registered size of your stand, you will receive a number of free exhibitor passes and can register events for the Leipzig liest reading festival. You can find out how many in the Special Conditions of Participation or on page 20.

Sample quote	Registration by 30.09.2022 (Early-bird)	Registration from 01.10.2022
Trade fair rental incl. stand construction (6 m ²)	€ 1,200.00	€ 1,320.00
AUMA fee	€ 3,60	€ 3.60
Electrical connection (compulsory)	€ 154.00	€ 154.00
Communication flat rate (i.e. compulsory entry in the exhibitor directory)	€ 89.00	€ 89.00
Free exhibitor passes (for the main exhibitor according to Stand size + one pass for each co-exhibitor)	2 passes	2 passes
Co-exhibitor fee, where applicable		
Leipzig liest fee 1, where applicable		
Leipzig liest fee 2, where applicable		
Total costs	€ 1,446.60	€ 1,566.60

Updated: July 2022, subject to change

All prices plus VAT.



COMPLETE STANDS

Complete stand "Standard" (from 8 m²)

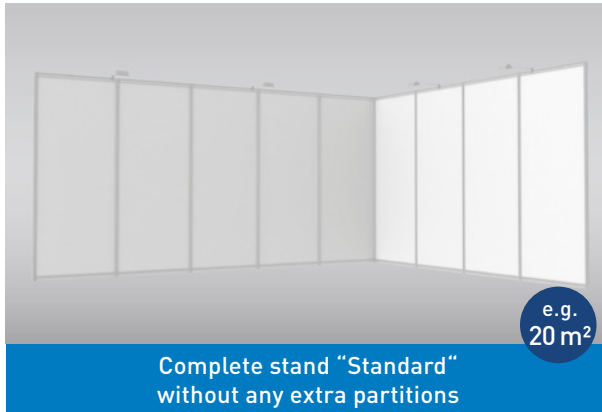

Our services

- | **Partition wall system**, 100x250 cm (WxH), white (other colours at additional price)
- | **Additional partitions available for a fee**, 27 € per metre
- | **Lighting**, 1 Long-arm spotlight per 5 m² stand area
- | **Triple socket** (The power connection will be charged separately and is compulsory)

Additional services

Depending on the registered size of your stand, you will receive a number of free exhibitor passes and can register events for the Leipzig liest festival. You can find out how many in the Special Conditions of Participation or on page 20.

Sample quote for an Exhibition Area of 20 m²

	Registration by 30.09.2022 (Early-bird)	Registration from 01.10.2022
Trade fair rental incl. stand construction (20 m ²)	€ 5,000.00	€ 5,500.00
AUMA fee	€ 12.00	€ 12.00
Electrical connection (compulsory)	€ 212.00	€ 212.00
Communication flat rate (i.e. compulsory entry in the exhibitor directory)	€ 193.00	€ 193.00
Free exhibitor passes (for the main exhibitor according to Stand size + one pass for each co-exhibitor)	4 passes	4 passes
Co-exhibitor fee, where applicable		
Leipzig liest fee 1, where applicable		
Leipzig liest fee 2, where applicable		
Total costs	€ 5,417.00	€ 5,917.00

Updated: July 2022, subject to change