

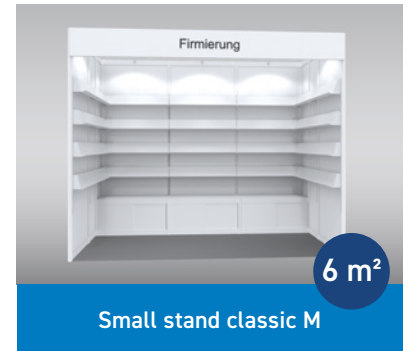

# EXHIBITION STAND OFFERS

## Overview of small and complete stand packages

Manga-Comic-Con offers exhibitors complete stand packages of various types. As our Self-build stander, FAIRNET is responsible for overall stand construction. All you have to do is arrange or decorate your stand. Below you can find a comparison of the various complete stand packages, explanations of the options and a sample quote for trade fair rental and fees in each case. According to our possibilities in hall layout and your wishes, the placement takes place as row, corner, head or block stand. Read more on page 12.



Stand construction	Classic S	Classic S without partition	Classic M
Partition wall system 100x250 cm (WxH), white*	✓	✓	✓
Fascia, 30 cm high, white	✓	✓	✓
1 Logo or 1 Lettering (Futura, dark grey), 10 cm high, max. 25 signs	✓	✓	✓
Bookshelves, white	✓	✓	✓
Platforms with sliding doors, white (please order door lock separately)	✓	✓	✓
Long-arm spotlight	✓	✓	✓
Needle-felt floor covering	✓	✓	✓
Triple socket (The power connection will be charged separately and is mandatory)	✓	✓	✓

\*other colours available for a fee

Mandatory fees: Electrical connection and Communication flat rate



# EXHIBITION STAND OFFERS

## Overview of small and complete stand packages



Small stand creative Pro S

4 m<sup>2</sup>



Small stand creative Pro M

6 m<sup>2</sup>

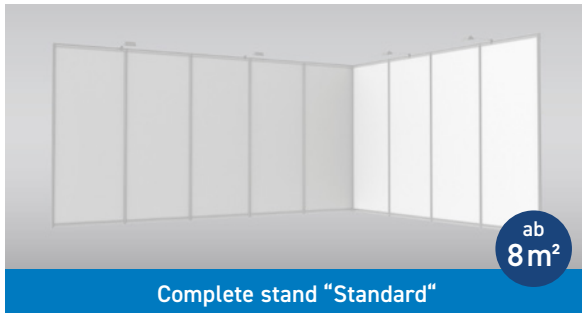

Complete stand "Standard"

ab  
8 m<sup>2</sup>

Stand construction	creative Pro S	creative Pro M	Complete stand "Standard"
Partition wall system 100x250 cm (WxH), white*	✓	✓	✓ extra high available for a fee
Fascia, 30 cm high, white	✓	✓	
1 Log or 1 Lettering (Futura, dark grey), 10 cm high, max. 25 signs	✓	✓	
Long-arm spotlight	✓	✓	✓
Needle-felt floor covering	✓	✓	
Triple socket (The power connection will be charged separately and is mandatory)	✓	✓	✓
2 "Miami" folding chairs	✓	✓	
3 Tables "Newport" (70x70 cm, 100x70 cm, 120x70 cm), black	✓		
3 Tables "Newport" (120x70 cm), black		✓	











\*other colours available for a fee

Mandatory fees: Electrical connection and Communication flat rate



# EXHIBITION STAND: OVERVIEW OF STAND TYPES

Your stand will be positioned as a row, corner, peninsula or island stand in keeping with our hall planning options, your wishes and the size of your stand. At the latest, you will receive your stand confirmation when you receive your stand allocation (from January 2024). The following overview shows examples of the various stand types. In the interest of the stands across from you, exhibitors with corner, peninsula and island stands may not position a closed wall along an aisle. Please note section 1.7 in our Special Conditions of Participation.

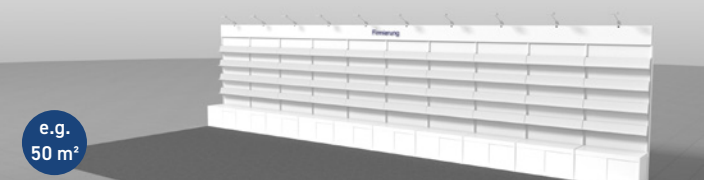
<p>Small Stand classic S 4 m<sup>2</sup></p>	<p>ROW STAND</p>		<p>CORNER STAND</p>	
<p>Small Stand classic S without a partition 4 m<sup>2</sup></p>	<p>ROW STAND</p>		<p>CORNER STAND</p>	
<p>Small Stand classic M 6 m<sup>2</sup></p>	<p>ROW STAND</p>		<p>CORNER STAND</p>	
<p>Small stand creative pro S 4 m<sup>2</sup></p>			<p>CORNER STAND</p>	
<p>Small stand creative pro M 6 m<sup>2</sup></p>			<p>CORNER STAND</p>	
<p>Complete stand 'Standard'</p>	<p>ROW STAND</p>	 <p>e.g. 20 m<sup>2</sup></p>	<p>CORNER STAND</p>	 <p>e.g. 20 m<sup>2</sup></p>
<p>Peninsula stand with 3 open sides</p>	<p>PENINSULA STAND</p>	 <p>e.g. 50 m<sup>2</sup></p>		



# COMPLETE STANDS

## Small stand classic S (4 m<sup>2</sup>)

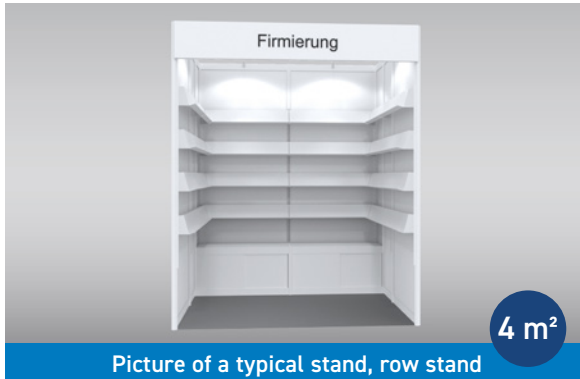

Picture of a typical stand, row stand

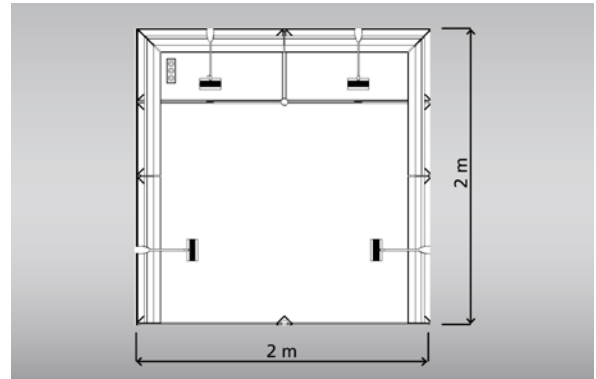

### Our services

- | **Partition wall system**, 100x250 cm (WxH), white (other colours at additional price)
- | **1 Logo or 1 Lettering** (Futura, dark grey), 10 cm high, max. 25 signs
- | **Fascia**, 30 cm high, white
- | **Bookshelves**, white
- | **Platforms with sliding doors**, white (please order door lock separately)
- | **Lighting**, Long-arm spotlight
- | **Needle-felt floor covering** anthracite, 3000
- | **Triple socket** (The power connection will be charged separately and is mandatory)

### Additional services

Depending on the registered size of your stand, you will receive a number of free exhibitor passes (2 passes) and can register events for the Leipzig liest reading festival (according to area key 1 event). You can find out how many in the Special Conditions of Participation or on page 24.

Sample quote	Registration by 10.09.2023 (Early-bird)	Registration from 11.09.2023
Trade fair rental incl. stand construction (4 m <sup>2</sup> )	€ 760.00	€ 844.00
AUMA fee	€ 2.40	€ 2.40
Electrical connection (mandatory)	€ 178.00	€ 178.00
Communication flat rate (i.e. mandatory entry in the exhibitor directory)	€ 93.00	€ 93.00
Free exhibitor passes (for the main exhibitor according to Stand size + one pass for each co-exhibitor)	2 passes	2 passes
Co-exhibitor fee, where applicable		
Leipzig liest fee 1, where applicable		
<b>Total costs</b>	<b>€ 1,033.40</b>	<b>€ 1,117.40</b>

All prices plus VAT.



# COMPLETE STANDS

## Small stand classic M (6 m<sup>2</sup>)

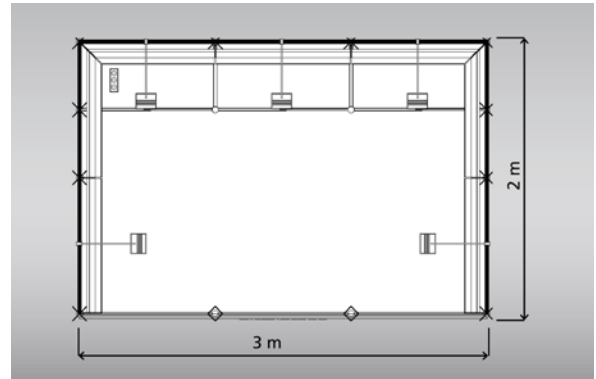
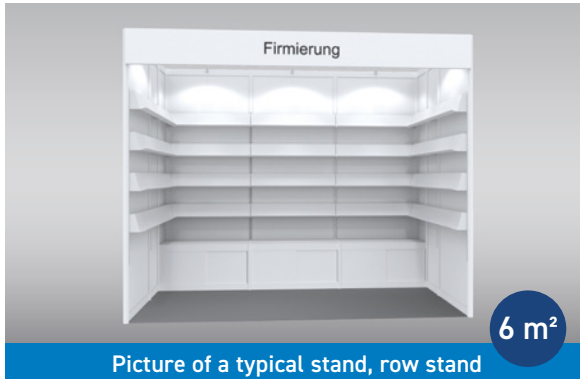

### Our services

- | **Partition wall system**, 100x250 cm (WxH), white (other colours at additional price)
- | **1 Logo or 1 Lettering** (Futura, dark grey), 10 cm high, max. 25 signs
- | **Fascia**, 30 cm high, white
- | **Bookshelves**, white
- | **Platforms with sliding doors**, white (Please order door lock separately)
- | **Lighting**, Long-arm spotlight
- | **Needle-felt floor covering** anthracite, 3000
- | **Triple socket** (The power connection will be charged separately and is mandatory)

### Additional services

Depending on the registered size of your stand, you will receive a number of free exhibitor passes (3 passes) and can register events for the Leipzig liest reading festival (according to area key 2 events). You can find out how many in the Special Conditions of Participation or on page 24.

Sample quote	Registration by 10.09.2023 (Early-bird)	Registration from 11.09.2023
Trade fair rental incl. stand construction (6 m <sup>2</sup> )	€ 1,212.00	€ 1,344.00
AUMA fee	€ 3.60	€ 3.60
Electrical connection (mandatory)	€ 178.00	€ 178.00
Communication flat rate (i.e. mandatory entry in the exhibitor directory)	€ 93.00	€ 93.00
Free exhibitor passes (for the main exhibitor according to Stand size + one pass for each co-exhibitor)	3 passes	3 passes
Co-exhibitor fee, where applicable		
Leipzig liest fee 1, where applicable		
<b>Total costs</b>	<b>€1,486.60</b>	<b>€1,618.60</b>

All prices plus VAT.



# COMPLETE STANDS

## Small stand classic S without partition (4 m<sup>2</sup>)



Picture of a typical stand, row stand

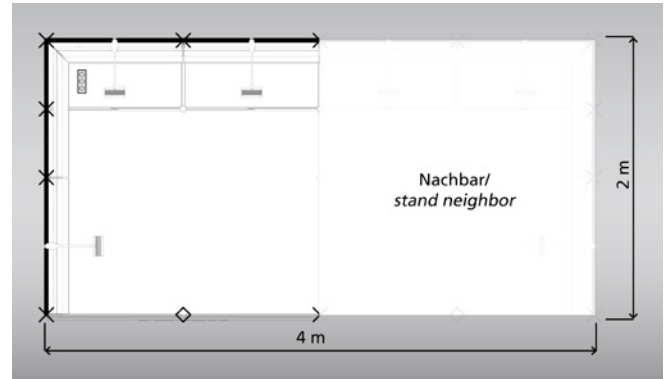

### Our services

- | **Partition wall system**, 100x250 cm (WxH), white (other colours at additional price)
- | **1 Logo or 1 Lettering** (Futura, dark grey), 10 cm high, max. 25 signs
- | **Fascia**, 30 cm high, white
- | **Bookshelves**, white
- | **Platforms with sliding doors**, white (Please order door lock separately)
- | **Lighting**, Long-arm spotlight
- | **Needle-felt floor covering** anthracite, 3000
- | **Triple socket** (The power connection will be charged separately and is mandatory)

### Additional services

Depending on the registered size of your stand, you will receive a number of free exhibitor passes (2 passes) and can register events for the Leipzig liest reading festival (according to area key 1 event). You can find out how many in the Special Conditions of Participation or on page 24.

Sample quote	Registration by 10.09.2023 (Early-bird)	Registration from 11.09.2023
Trade fair rental incl. stand construction (4 m <sup>2</sup> )	€ 1,024.00	€ 1,140.00
AUMA fee	€ 2.40	€ 2.40
Electrical connection (mandatory)	€ 178.00	€ 178.00
Communication flat rate (i.e. mandatory entry in the exhibitor directory)	€ 93.00	€ 93.00
Free exhibitor passes (for the main exhibitor according to Stand size + one pass for each co-exhibitor)	2 passes	2 passes
Co-exhibitor fee, where applicable		
Leipzig liest fee 1, where applicable		
<b>Total costs</b>	<b>€ 1,297.40</b>	<b>€ 1,413.40</b>

All prices plus VAT.



# COMPLETE STANDS

## Small stand creative Pro S (4 m<sup>2</sup>)



Picture of a typical stand, corner stand

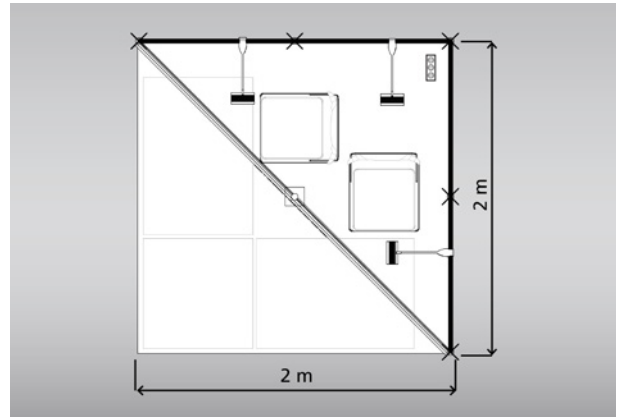

### Our services

- | **Partition wall system**, 100x250 cm (WxH), white (other colours at additional price)
- | **1 Logo or 1 Lettering** (Futura, dark grey), 10 cm high, max. 25 Signs
- | **Fascia**, 30 cm high, white
- | **Lighting**, Long-arm spotlight
- | **Needle-felt floor covering** anthracite, 3000
- | **Triple socket** (The power connection will be charged separately and is mandatory)
- | **2 "Miami" folding chairs**, Seat/backrest/frame: black, 33x35x47/72 cm
- | **3 "Newport" tables**, black, 70x70 cm, 100x70 cm, 120x70 cm

### Additional services

Depending on the registered size of your stand, you will receive a number of free exhibitor passes (2 passes) and can register events for the Leipzig liest reading festival (according to area key 1 event). You can find out how many in the Special Conditions of Participation or on page 24.

Sample quote	Registration bis 10.09.2023 (Early-bird)	Registration ab 11.09.2023
Trade fair rental incl. stand construction (4 m <sup>2</sup> )	€ 769.00	€ 844.00
AUMA fee	€ 2.40	€ 2.40
Electrical connection (mandatory)	€ 178.00	€ 178.00
Communication flat rate (i.e. mandatory entry in the exhibitor directory)	€ 93.00	€ 93.00
Free exhibitor passes (for the main exhibitor according to Stand size + one pass for each co-exhibitor)	2 passes	2 passes
Co-exhibitor fee, where applicable		
Leipzig liest fee 1, where applicable		
<b>Total costs</b>	<b>€ 1,042.40</b>	<b>€ 1,117.40</b>

All prices plus VAT.



# COMPLETE STANDS

## Small stand creative Pro M (6 m<sup>2</sup>)

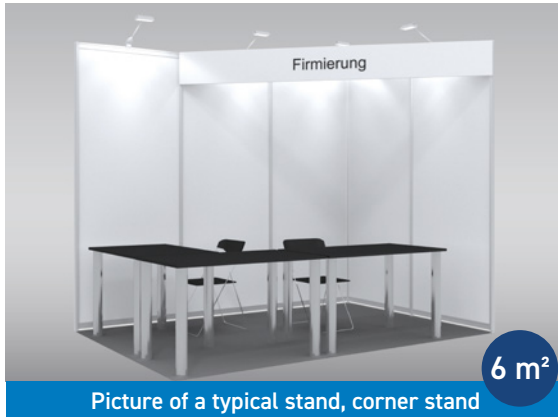

Picture of a typical stand, corner stand

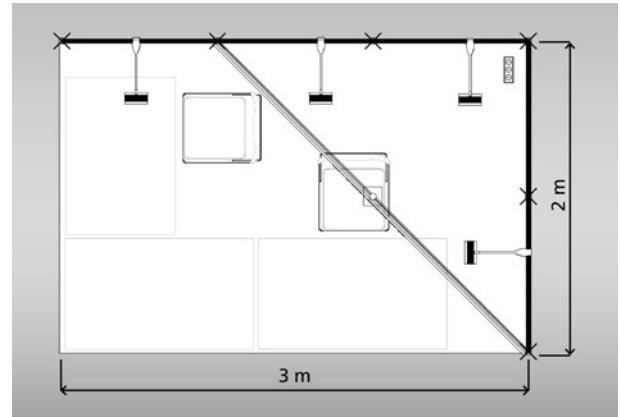

### Our services

- | **Partition wall system**, 100x250 cm (WxH), white (other colours at additional price)
- | **1 Logo or 1 Lettering** (Futura, dark grey), 10 cm high, max. 25 Signs
- | **Fascia**, 30 cm high, white
- | **Lighting**, Long-arm spotlight
- | **Needle-felt floor covering** anthracite, 3000
- | **Triple socket** (The power connection will be charged separately and is mandatory)
- | **2 "Miami" folding chairs**, Seat/backrest/frame: black, 33x35x47/72 cm
- | **3 tables "Newport"**, black, 120x70 cm

### Additional services

Depending on the registered size of your stand, you will receive a number of free exhibitor passes (3 passes) and can register events for the Leipzig liest reading festival (according to area key 2 events). You can find out how many in the Special Conditions of Participation or on page 24.

Sample quote	Registration by 10.09.2023 (Early-bird)	Registration from 11.09.2023
Trade fair rental incl. stand construction (6 m <sup>2</sup> )	€ 1,212.00	€ 1,344.00
AUMA fee	€ 3,60	€ 3.60
Electrical connection (mandatory)	€ 178.00	€ 178.00
Communication flat rate (i.e. mandatory entry in the exhibitor directory)	€ 93.00	€ 93.00
Free exhibitor passes (for the main exhibitor according to Stand size + one pass for each co-exhibitor)	3 passes	3 passes
Co-exhibitor fee, where applicable		
Leipzig liest fee 1, where applicable		
<b>Total costs</b>	<b>€ 1,486.60</b>	<b>€ 1,618.60</b>

All prices plus VAT.





# COMPLETE STANDS

## Complete stand "Standard" (from 8 m<sup>2</sup>)

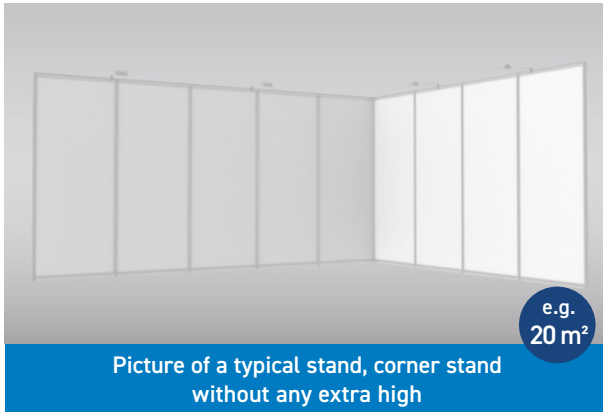

### Our services

- | **Partition wall system**, 100x250 cm (WxH), white (other colours at additional price)
- | **Additional partitions available for a fee**, Price on request
- | **Lighting**, 1 Long-arm spotlight per 5 m<sup>2</sup> stand area
- | **Triple socket** (The power connection will be charged separately and is mandatory)

### Additional services

Depending on the registered size of your stand, you will receive a number of free exhibitor passes and can register events for the Leipzig liest reading festival. You can find out how many in the Special Conditions of Participation or on page 24.

Sample quote for an Exhibition Area of 20 m <sup>2</sup>	Registration by 10.09.2023 (Early-bird)	Registration from 11.09.2023
Trade fair rental incl. stand construction (20 m <sup>2</sup> )	€ 5,100.00	€ 5,660.00
AUMA fee	€ 12.00	€ 12.00
Electrical connection (mandatory)	€ 233.00	€ 233.00
Communication flat rate (i.e. mandatory entry in the exhibitor directory)	€ 203.00	€ 203.00
Free exhibitor passes (for the main exhibitor according to Stand size + one pass for each co-exhibitor)	4 passes	4 passes
Co-exhibitor fee, where applicable		
Leipzig liest fee 1, where applicable		
<b>Total costs</b>	<b>€ 5,548.00</b>	<b>€ 6,108.00</b>

All prices plus VAT.